

A ピンクの線を参考に切り取ってください。 Cut with reference to the pink line

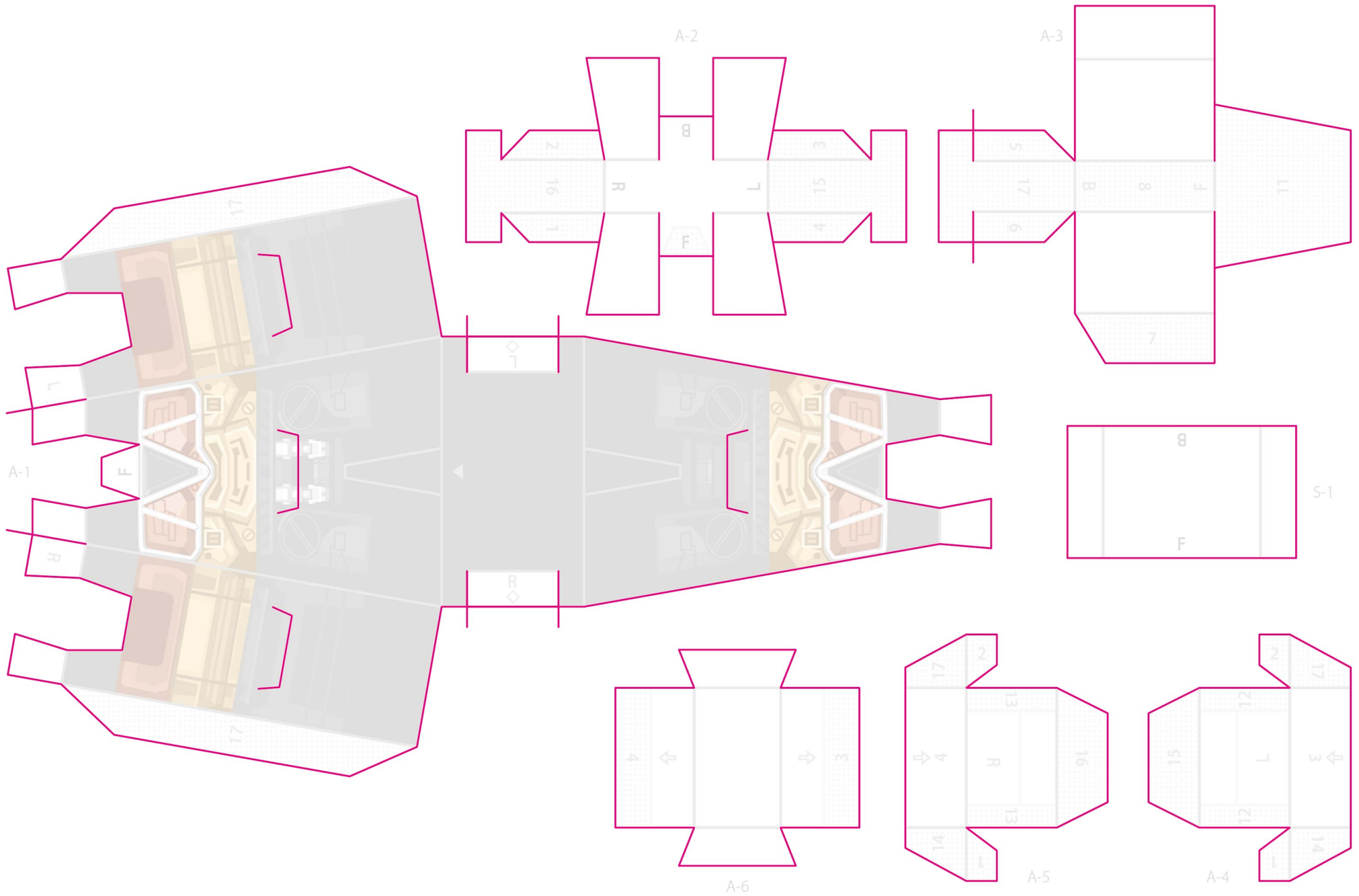

B

ピンクの線を参考に切り取ってください。 Cut with reference to the pink line

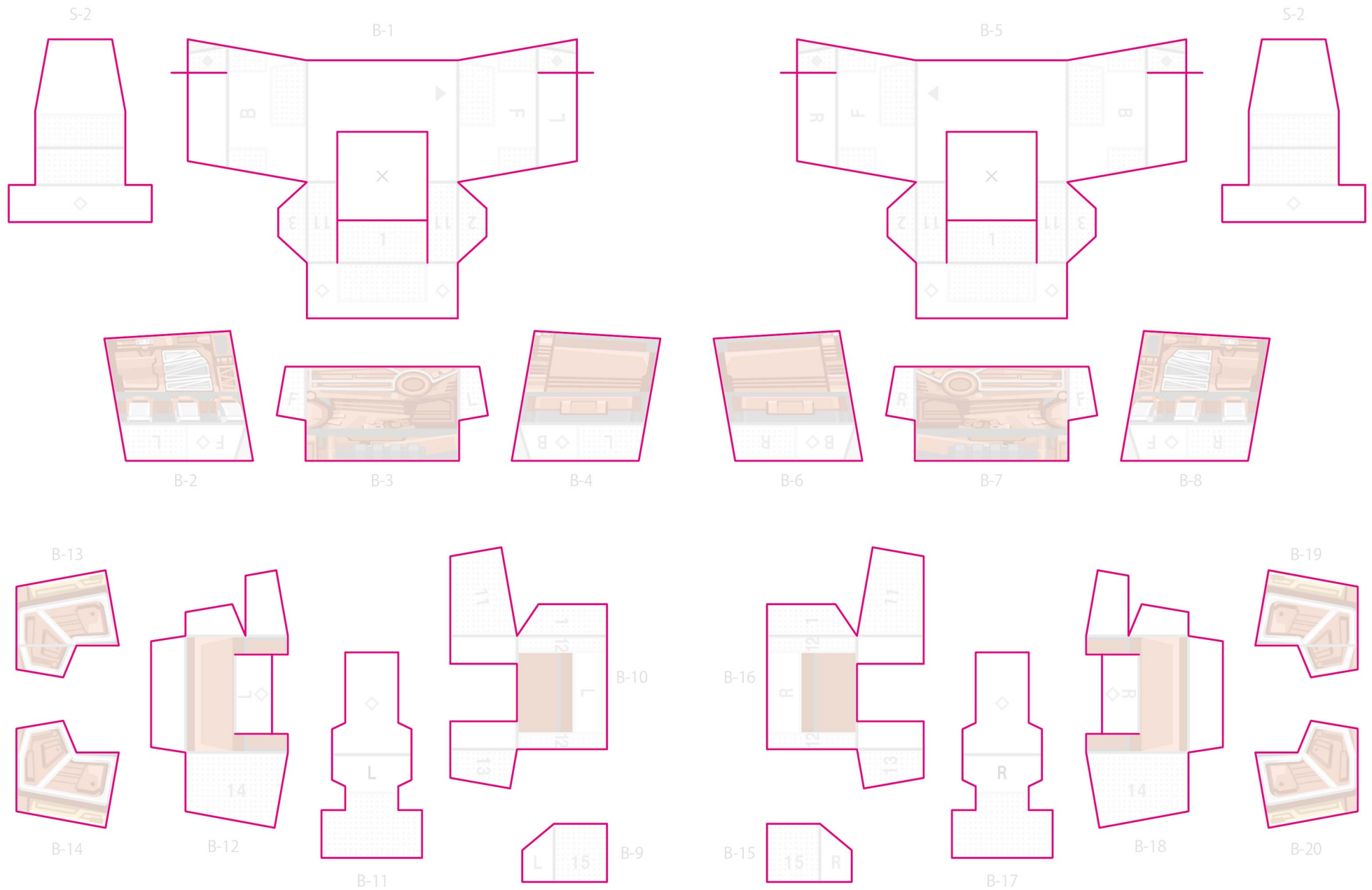

C

ピンクの線を参考に切り取ってください。 Cut with reference to the pink line

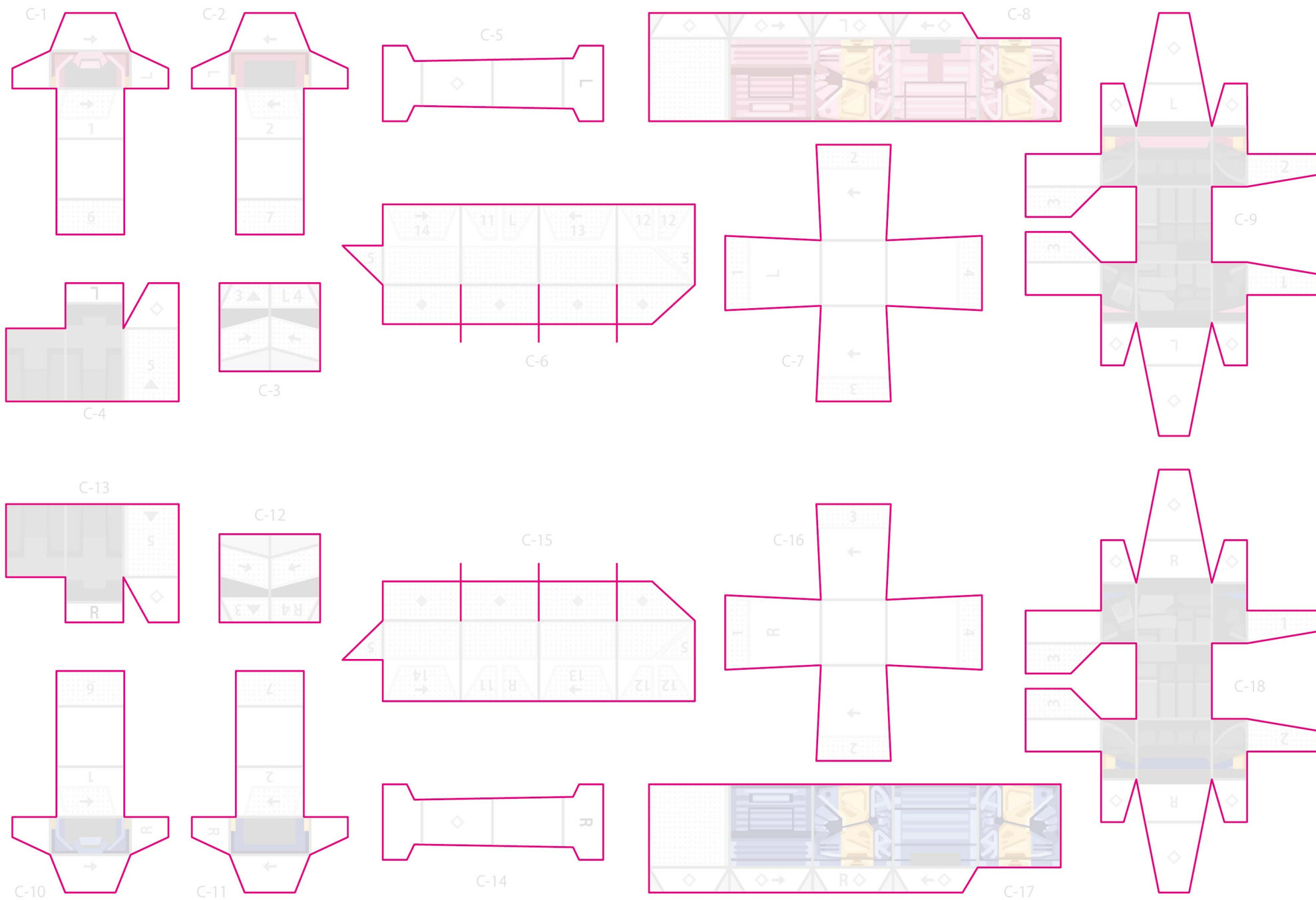

D

ピンクの線を参考に切り取ってください。 Cut with reference to the pink line

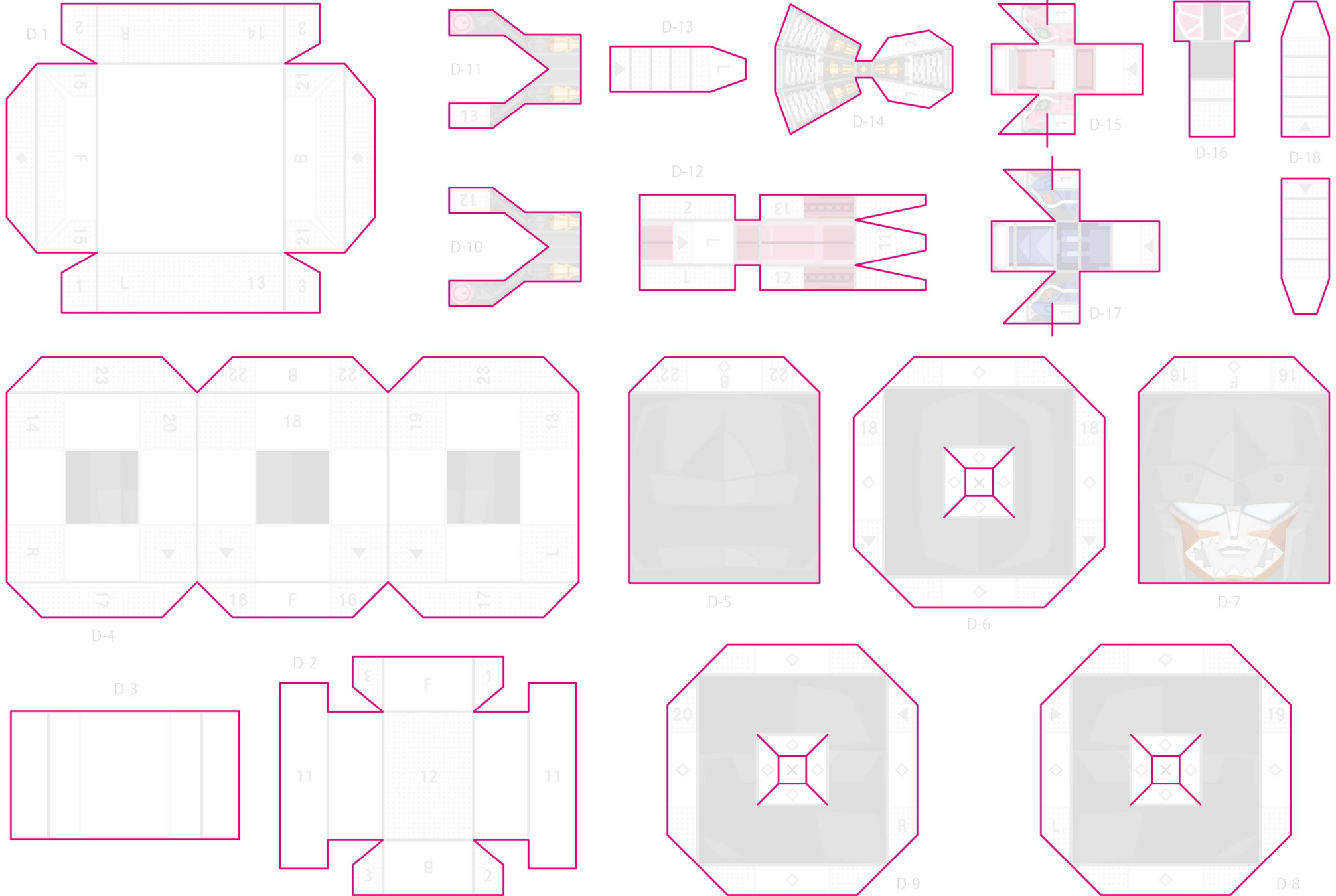

E

ピンクの線を参考に切り取ってください。 Cut with reference to the pink line

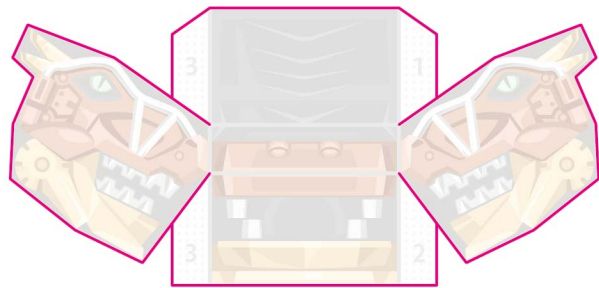

E-3



E-4

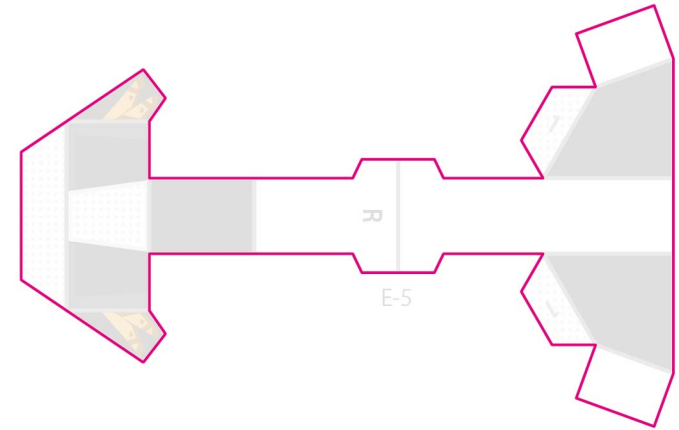

E-5

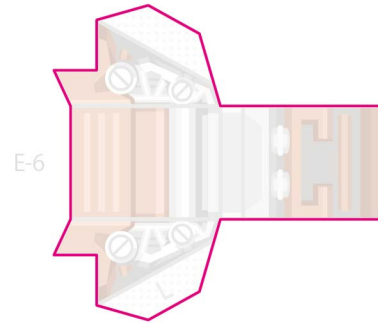

E-6

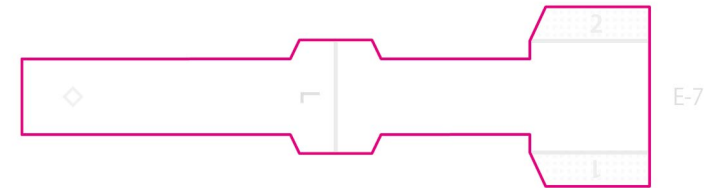

E-7

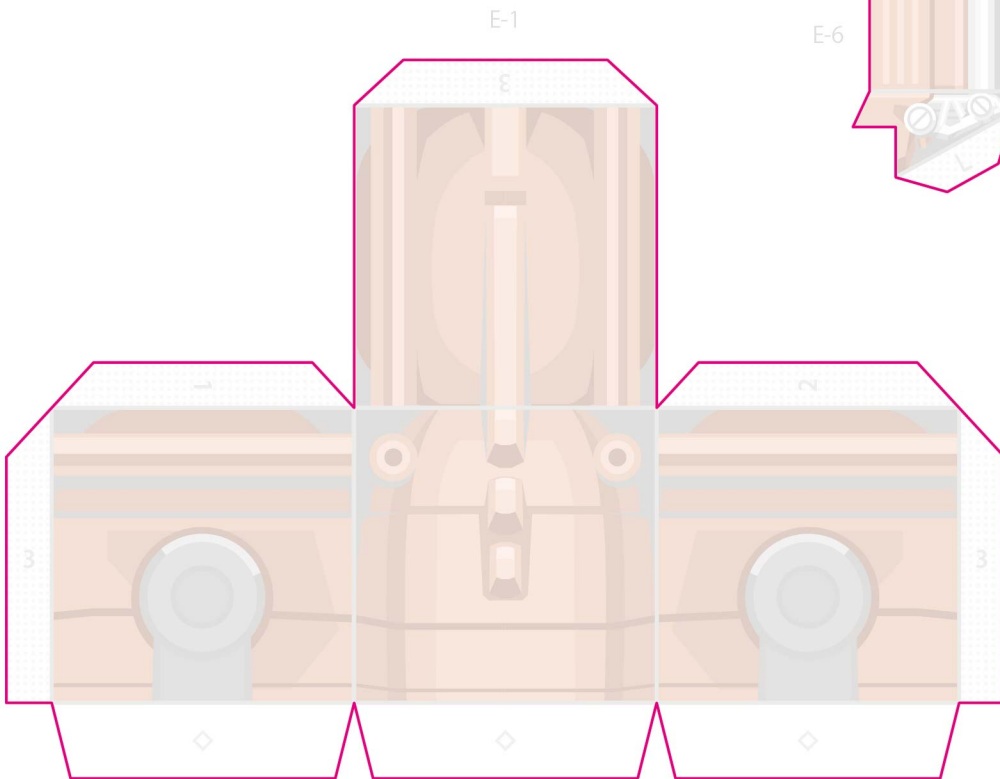

E-1

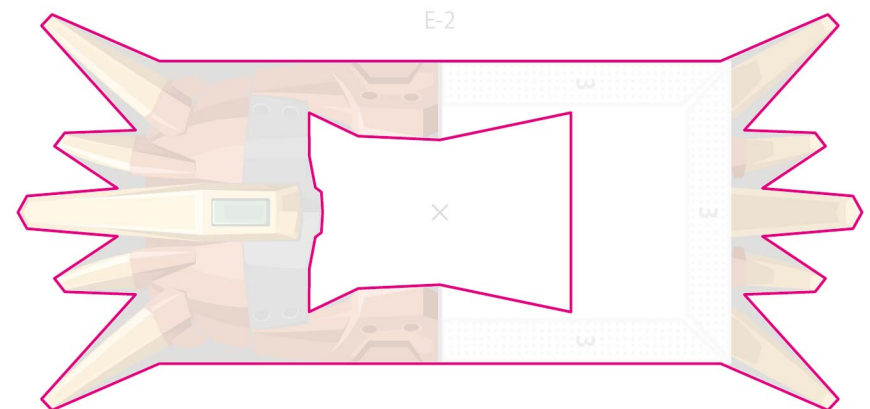

E-2

F

ピンクの線を参考に切り取ってください。 Cut with reference to the pink line

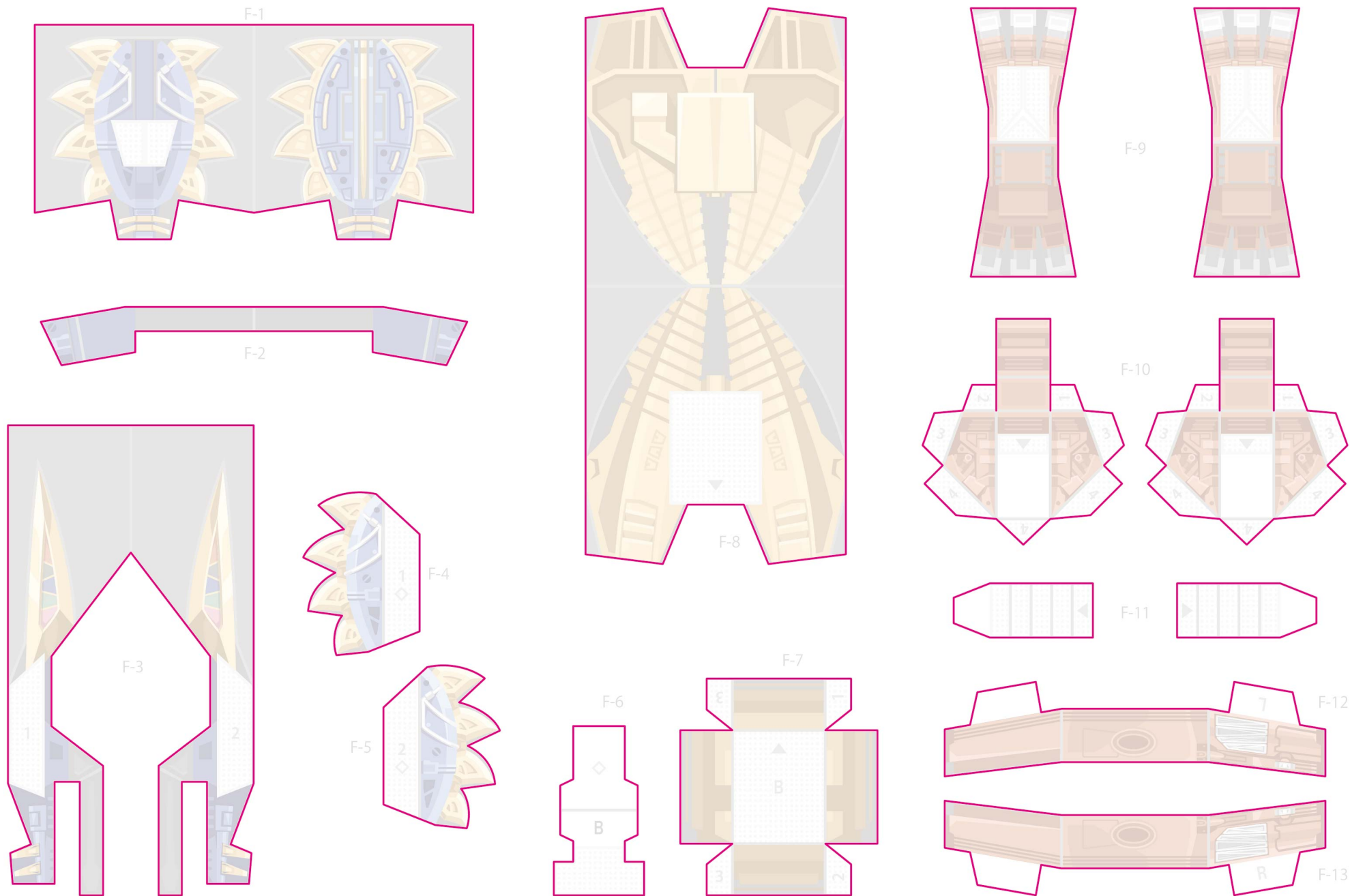

G

ピンクの線を参考に切り取ってください。 Cut with reference to the pink line

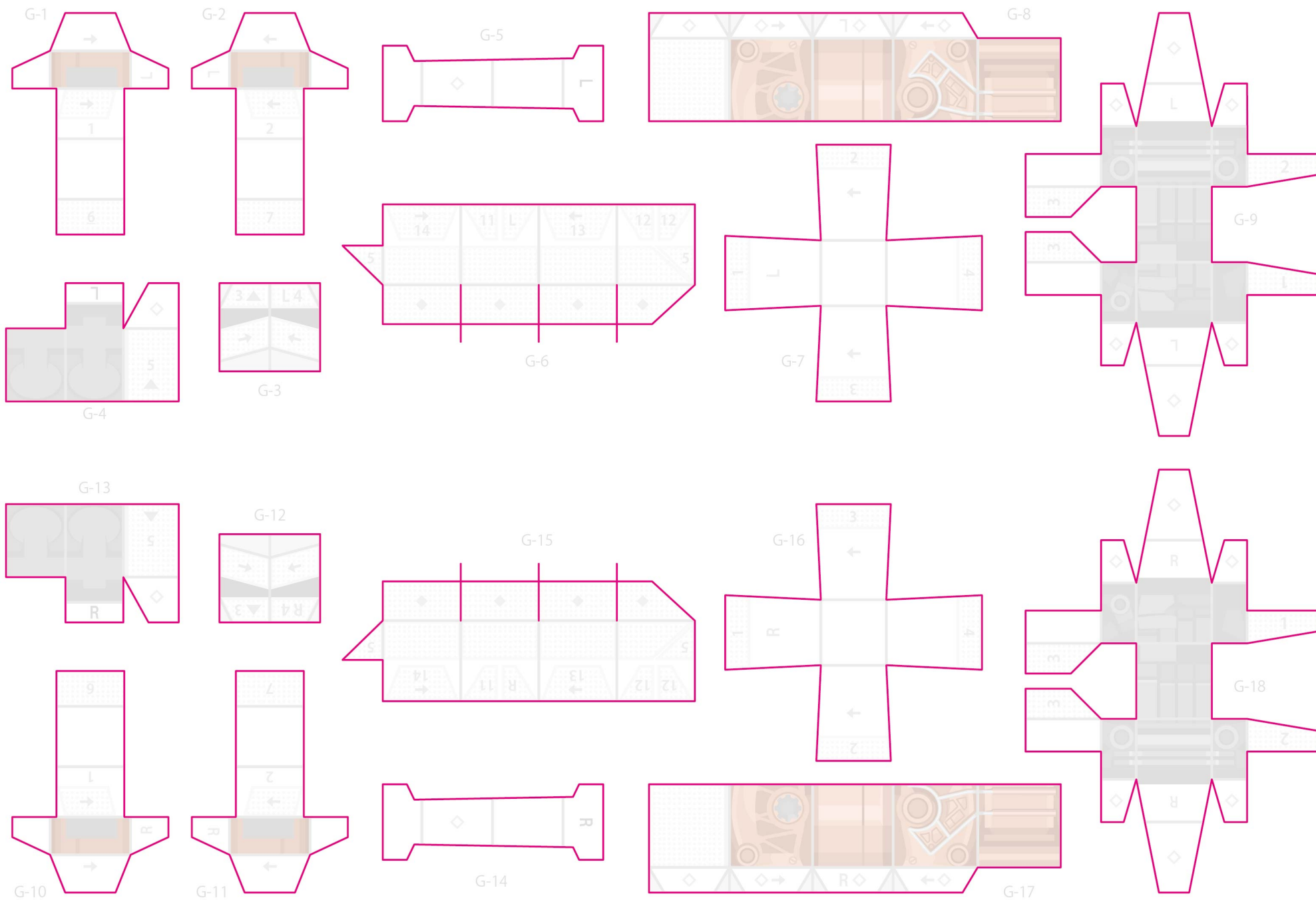

A それぞれの点線を参考に折り目を付けてください。 Make a crease with reference to the dotted line

..... やまおり Mountain fold - - - - たにおり Valley fold

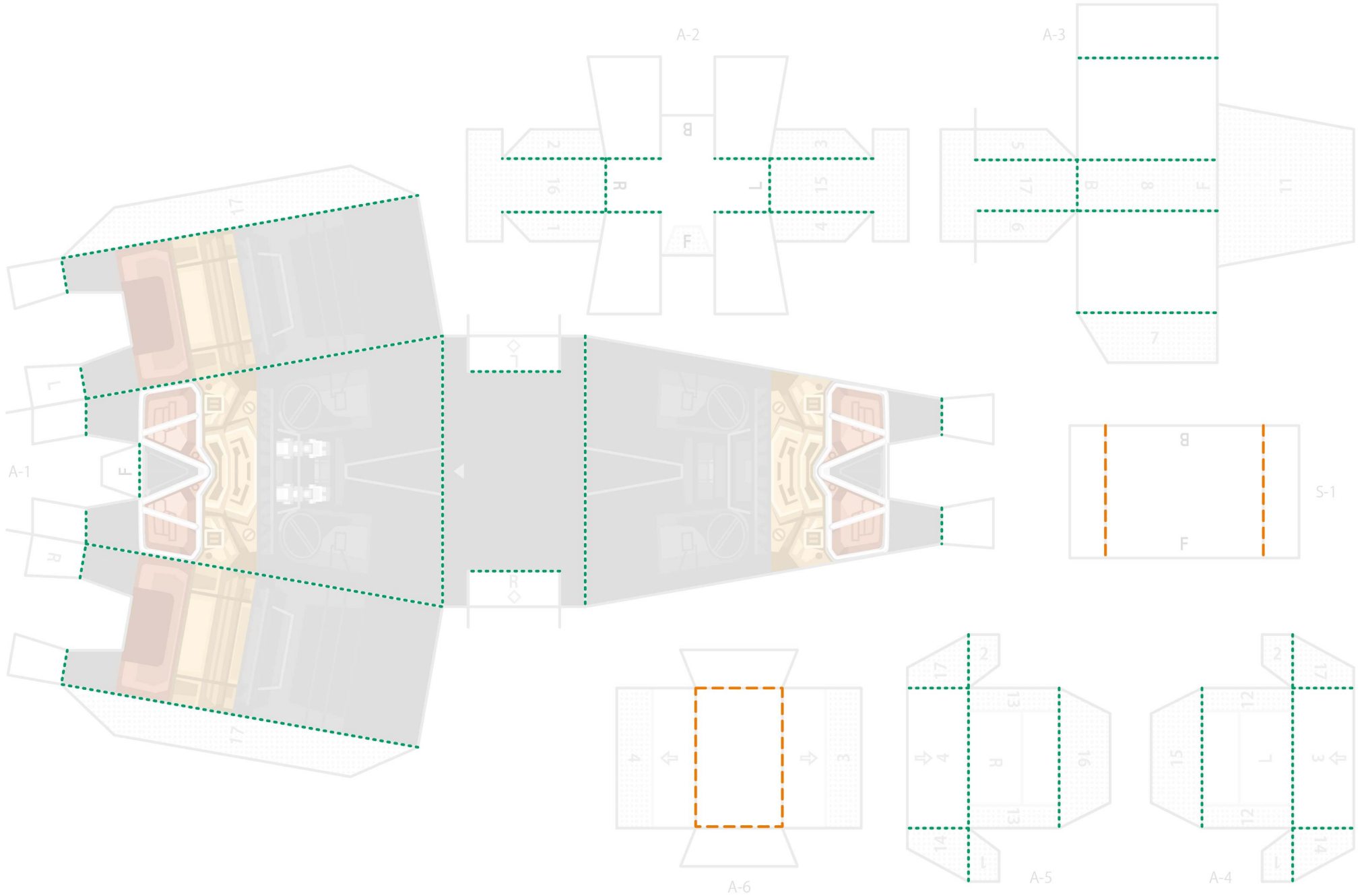

B それぞれの点線を参考に折り目を付けてください。 Make a crease with reference to the dotted line

----- やまおり Mountain fold - - - - たにおり Valley fold

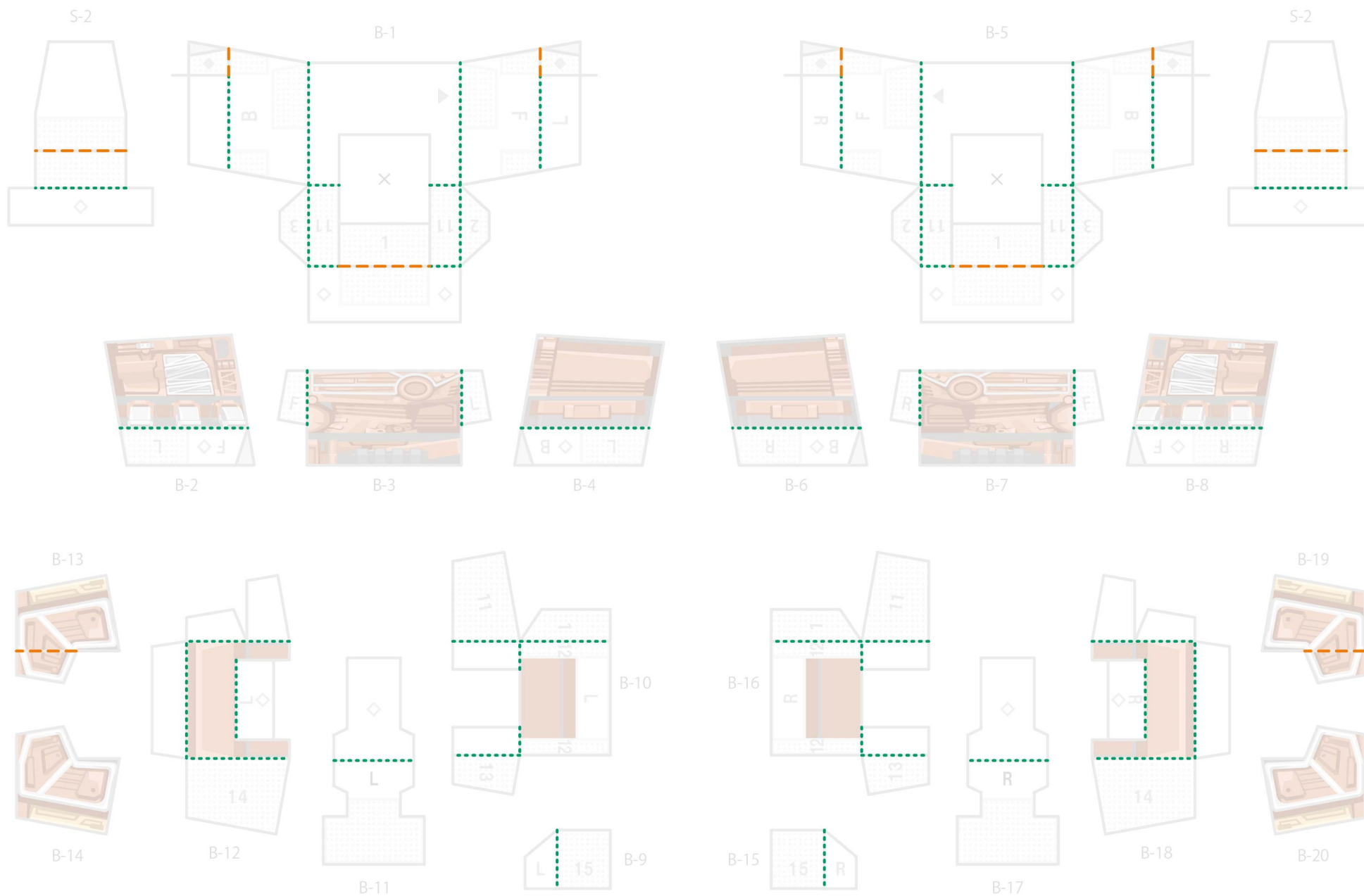

C

それぞれの点線を参考に折り目を付けてください。 Make a crease with reference to the dotted line

----- やまおり Mountain fold - - - - たにおり Valley fold

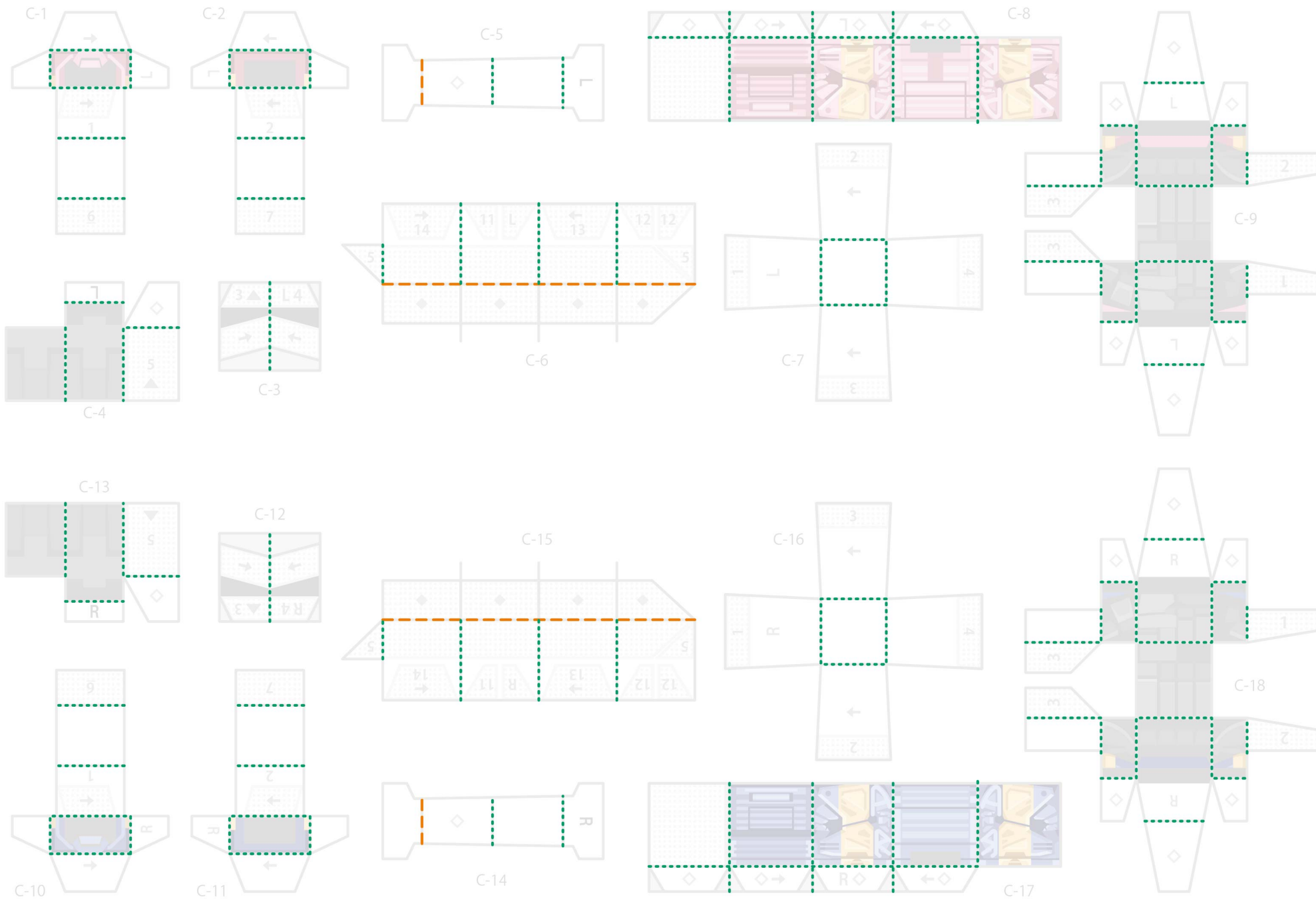

D それぞれの点線を参考に折り目を付けてください。 Make a crease with reference to the dotted line

----- やまおり Mountain fold - - - - たにおり Valley fold

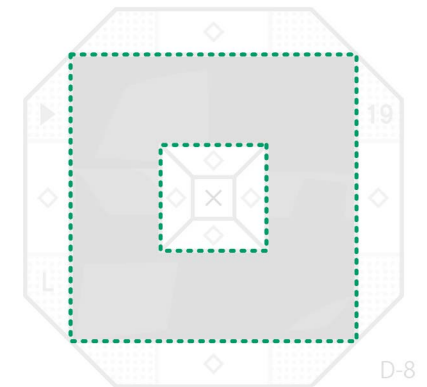
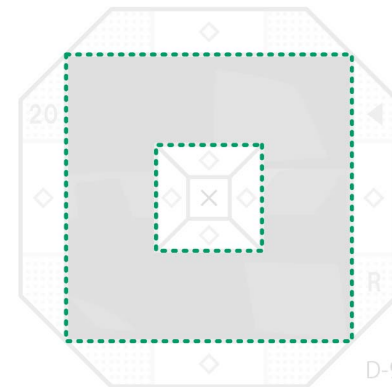
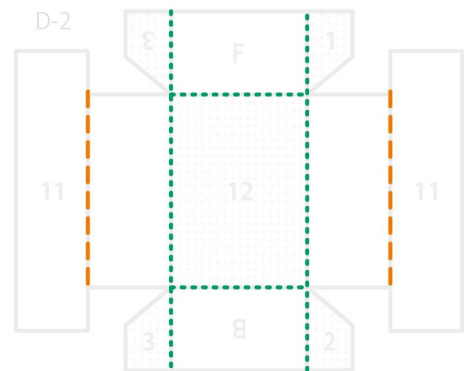
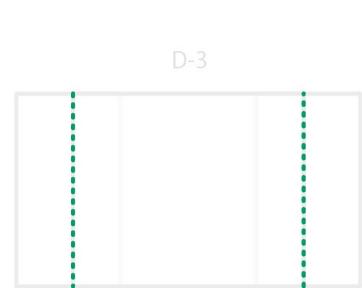
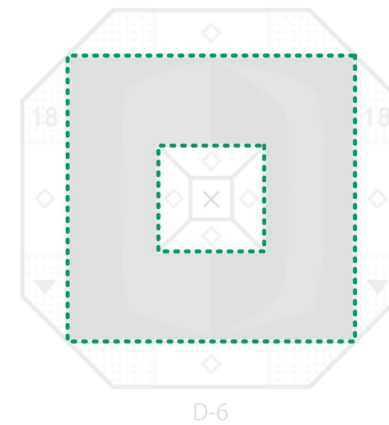
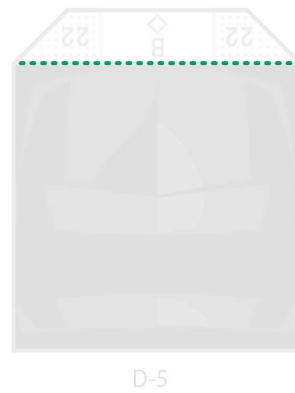
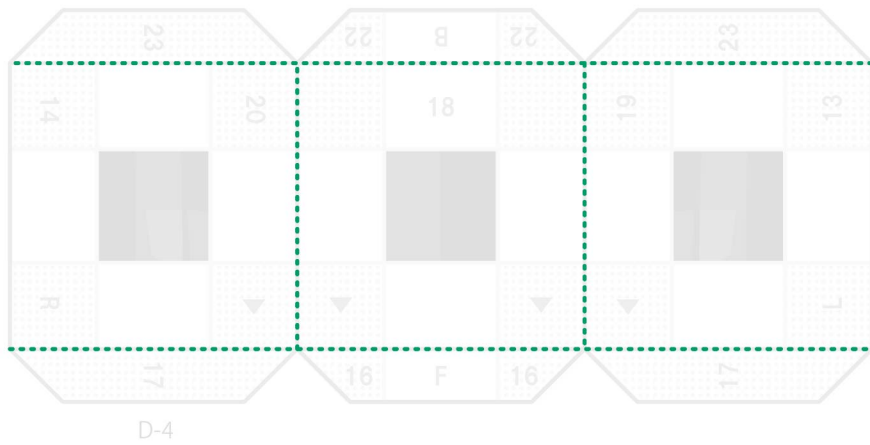
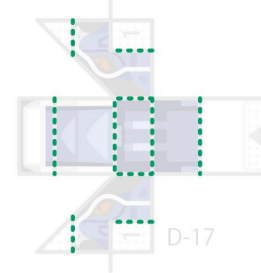
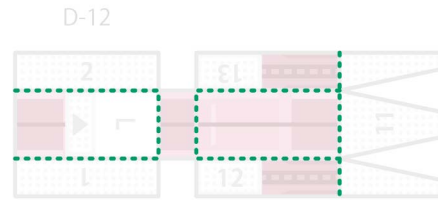
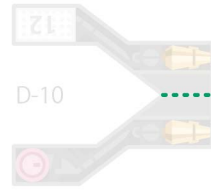
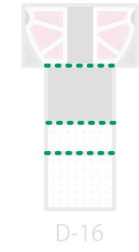
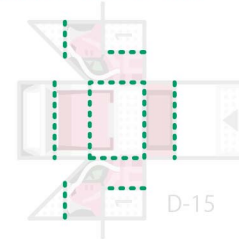
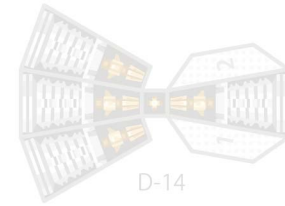
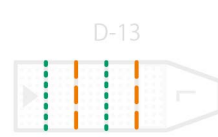
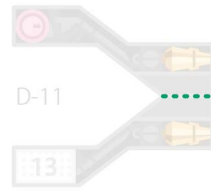
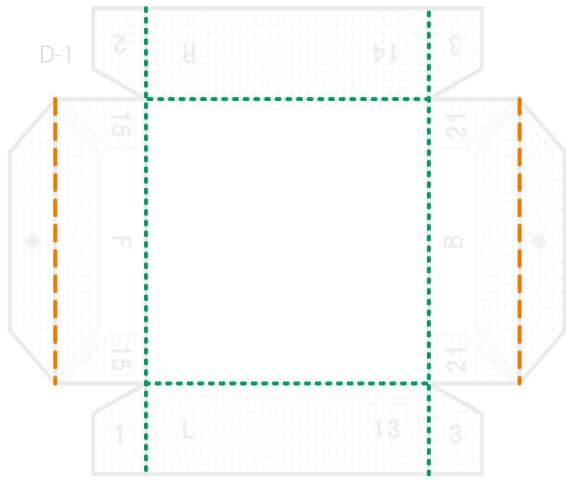

E それぞれの点線を参考に折り目を付けてください。 Make a crease with reference to the dotted line

..... やまおり Mountain fold - - - - たにおり Valley fold

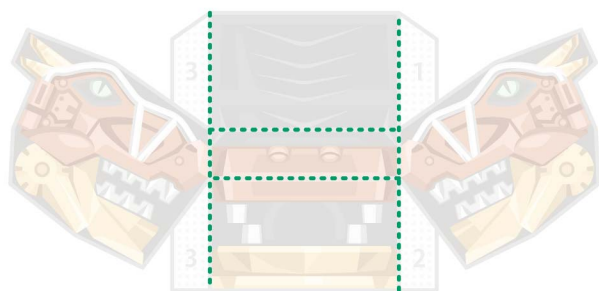

E-3



E-4

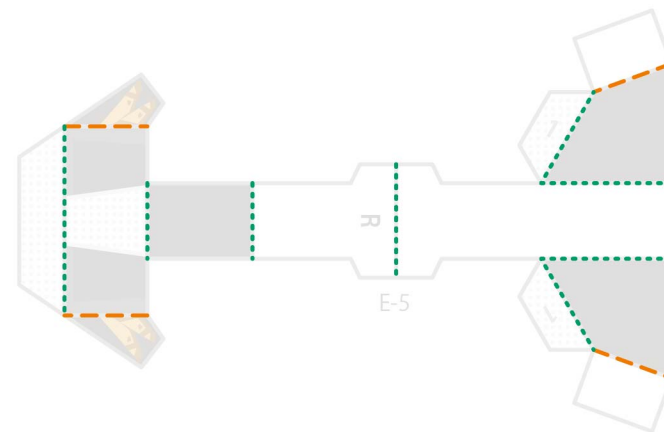

E-5

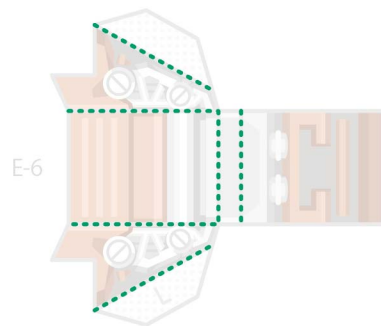

E-6

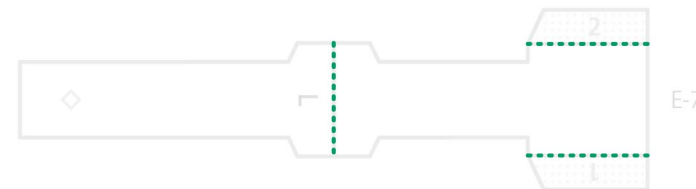

E-7

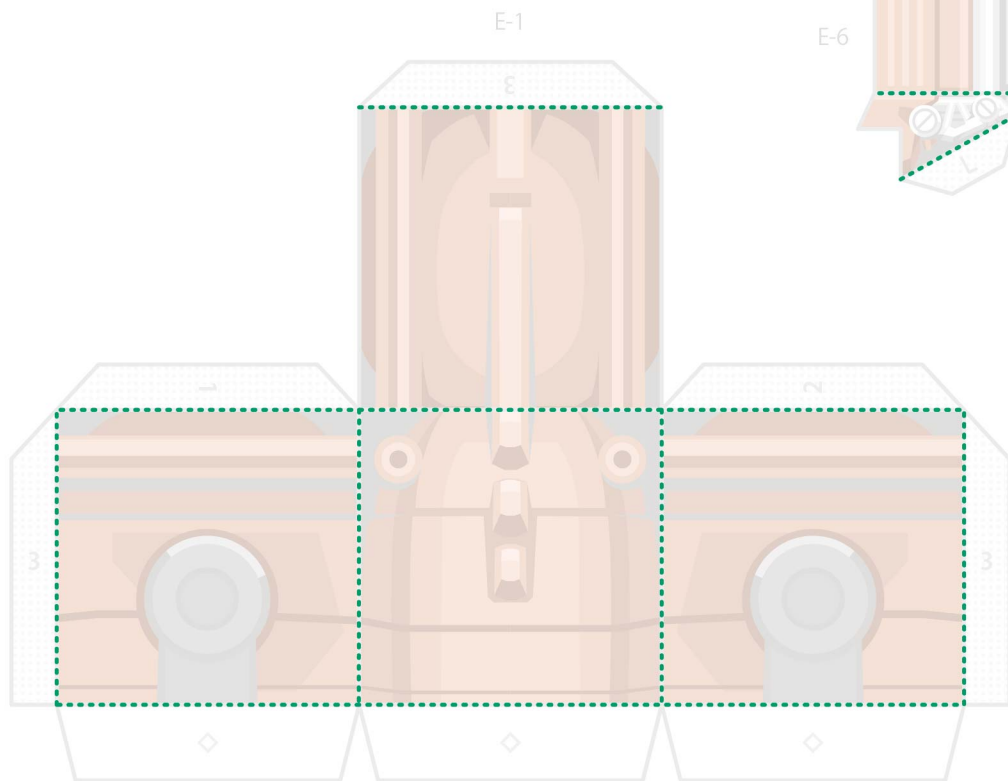

E-1

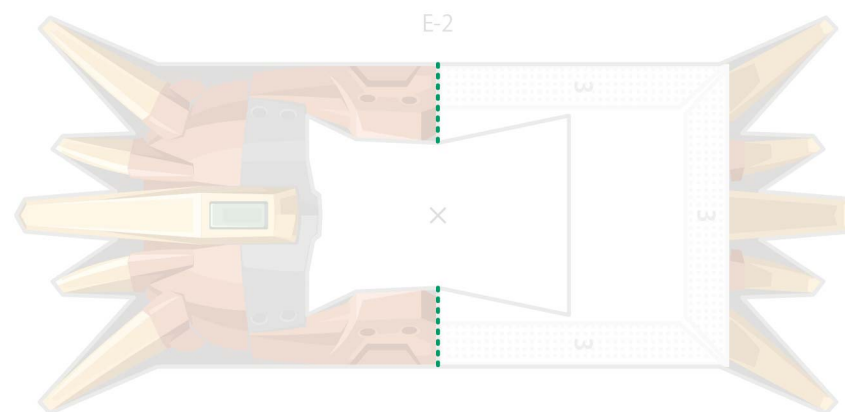

E-2

F それぞれの点線を参考に折り目を付けてください。 Make a crease with reference to the dotted line

..... やまおり Mountain fold - - - - たにおり Valley fold

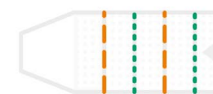
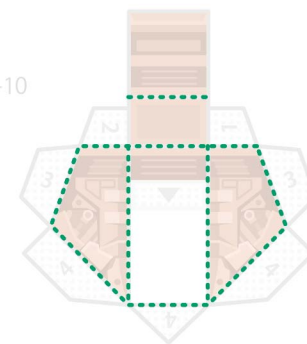
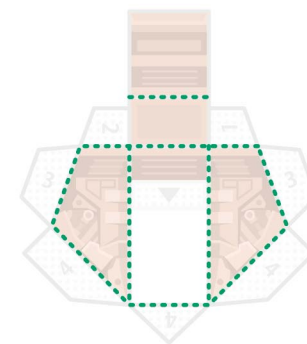
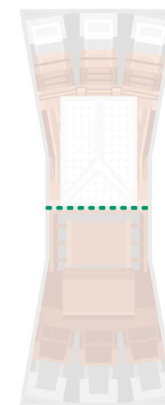
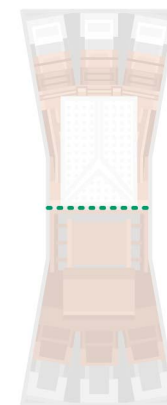
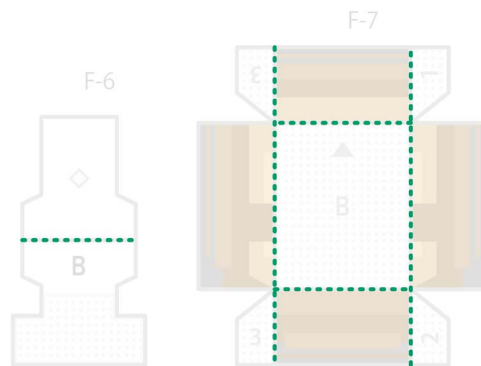
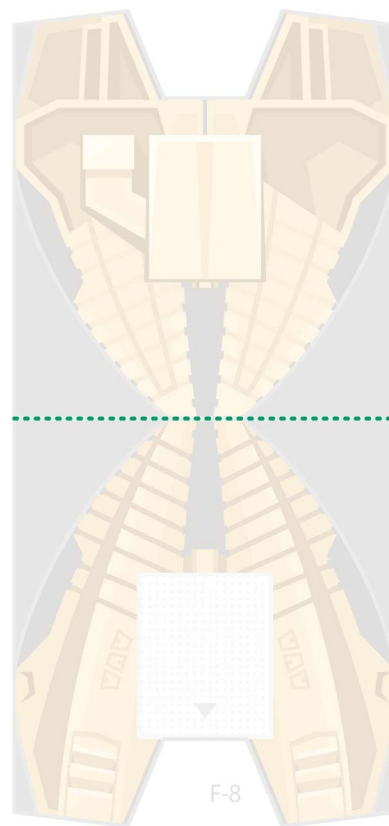
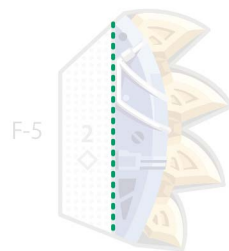
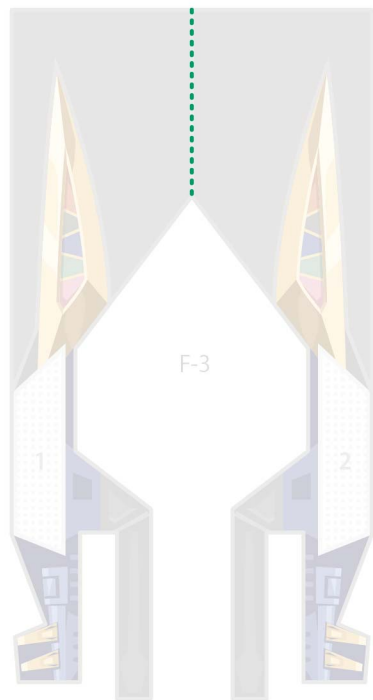
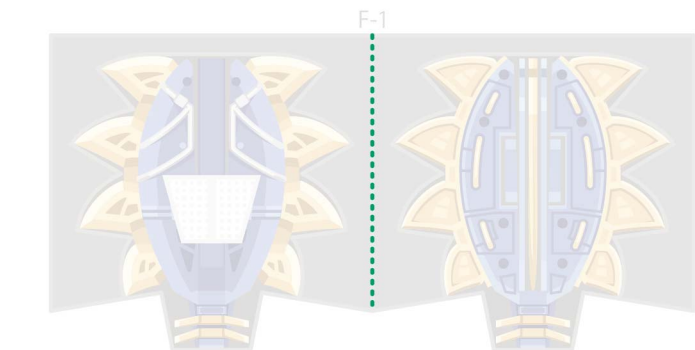

G

それぞれの点線を参考に折り目を付けてください。 Make a crease with reference to the dotted line

----- やまおり Mountain fold - - - - たにおり Valley fold

